

## Guard Locking Switch Stainless Steel Type: HYGIELOCK KL4-SS

## FEATURES:



IP69K

Spring to lock when actuator is inserted. Energise solenoid to unlock.

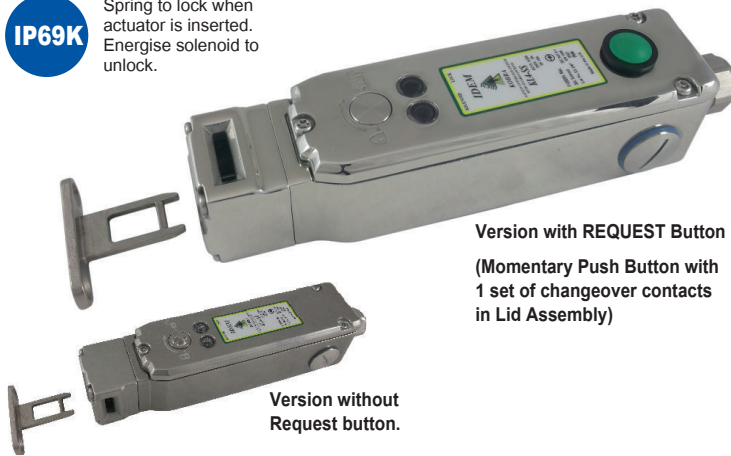

Version with REQUEST Button  
(Momentary Push Button with  
1 set of changeover contacts  
in Lid Assembly)

Version without  
Request button.

## Solenoid Locking Interlock Safety Switch featuring Guard Holding up to 3000N (300Kg) (F1Max)

The KL4-SS Series Guard Locking switches have a rugged Stainless Steel 316 body and have been developed with a holding force of 3000N to keep medium to large guard doors closed until hazards have been removed.

They are designed to cope with the rigorous applications of the Food Processing, Packaging, Pharmaceutical and Petro-Chemical Industries.

They have IP69K enclosure protection and can be high pressure hosed with detergent at high temperature.

With a slim body design of under 50mm wide they can be fitted to 50mm (2") frame sections or to applications where space is restricted. The Head will rotate to provide up to 8 actuator entry positions.

2 manual override points are provided (this is achieved by using an anti-tamper key).

## CONTACTS/LED DIAGNOSTICS:

A unique mechanical design featuring 2 independent contact blocks gives a high function and diagnostic specification.

4NC Safety Contacts

1NO Auxiliary Contact (Guard Open)

LED1 Solenoid Power

LED2 Lock Status indication or 1NO Auxiliary Contact (Lock Open)

## ACTUATOR OPTIONS (see p100)

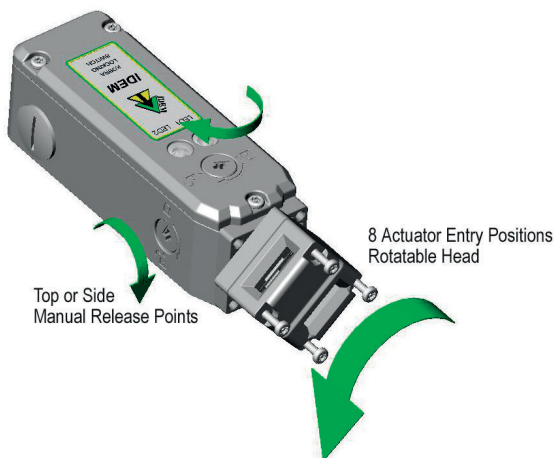
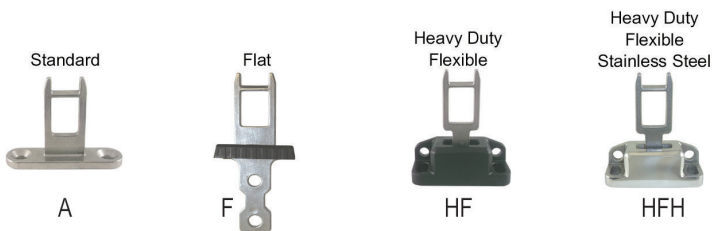

## INSERTION OF ACTUATOR

6.0 5.0 0mm

11/12	Open	
21/22	Open	
33/34		Open
43/44		Open

For all IDEM switches the normally closed (NC) circuits are closed when the guard is closed actuator inserted.

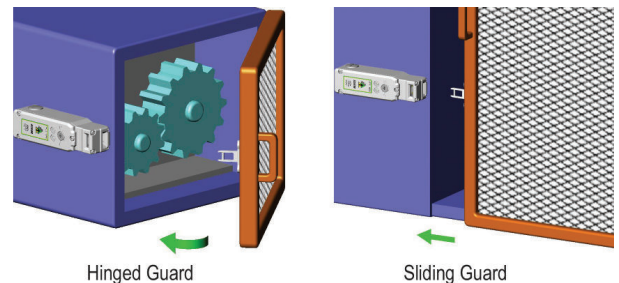

## FUNCTIONAL SPECIFICATIONS:

Positive Break Contacts to EN60947-5-1

High Functional Safety to ISO13849-1

Stainless Steel 316 Housings

Connects to most Safety Relays to give up to PLe Cat.4

IP69K suitable for SIP and CIP Processes

Will fit on 50mm frame sections or where space is restricted

4NC Safety Contacts independently selectable

**Standards:** ISO14119 EN60947-5-1 EN62024-1  
ISO13849-1 EN62061 UL508

**Safety Classification and Reliability Data:**

Mechanical Reliability B10d	2.5 x 10 <sup>6</sup> operations at 100mA load
ISO13849-1	Up to PLe depending upon system architecture
EN62061	Up to SIL3 depending upon system architecture
Safety Data – Annual Usage	8 cycles per hour/24 hours per day/365 days
	MTTFd 356 years
Solenoid Voltage (by Sales Number)	24V ac/dc or 110Vac or 230Vac
Solenoid Wattage	12W
LED2 Supply Voltage	24Vdc
Utilization Category	AC15 A300 3A
Thermal Current (Ith)	5A
Rated Insulation/Withstand Voltages	600Vac/2500Vac
Travel for Positive Opening	10mm
Actuator Entry Minimum Radius	175mm Standard 100mm Heavy Duty
Maximum Approach/Withdrawal Speed	600mm/s
Holding Force	F1Max 3000N Fzh 2307N
Body Material	Stainless Steel 316
Enclosure Protection	IP69K IP67
Operating Temperature	-25C +50C
Vibration	IEC 68-2-6 10-55Hz + 1Hz
	Excursion 0.35mm 1 octave/min
Conduit Entry	Various (See Sales Number)
Fixing	4 x M5

# Guard Locking Switch Stainless Steel Type: HYGIELOCK KL4-SS

## SCHEMATIC CIRCUIT & DIMENSIONS:

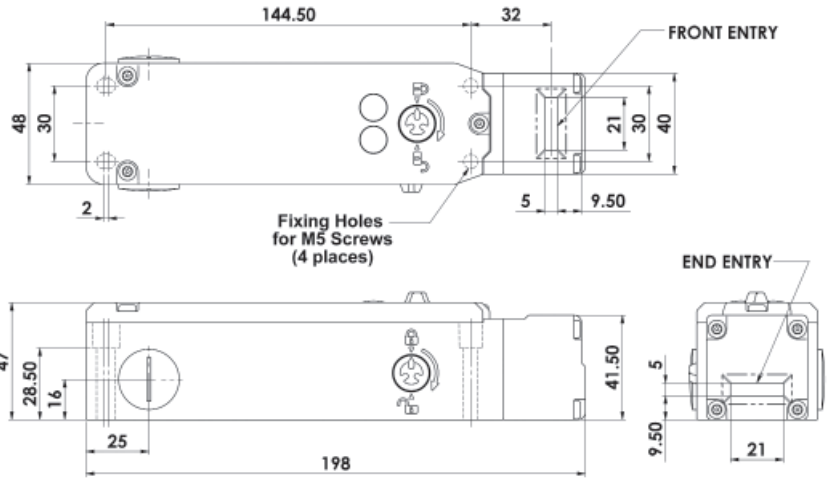
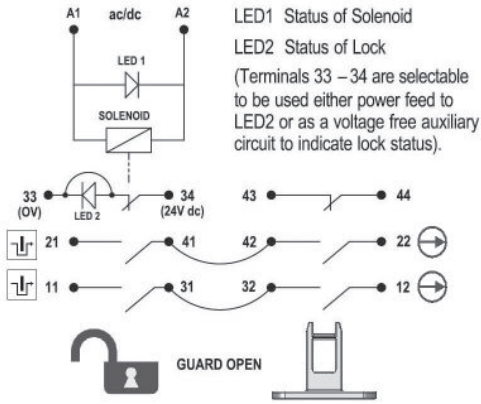

## ACCESSORIES (see p100-101 and Gate Bolts Section 6)

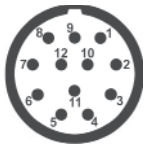

Quick Connect (QC) M23 12 Way Male Plug Connector Length 24mm Pin View from Switch	Switch Circuit
1 3	A1 A2
4 6	11/12
7 8	21/22
2 5	43/44
9	33
10	34
Earth	12



FEMALE QC LEADS	LENGTH	SALES NUMBER
M23 12 Way	5m (15ft)	140143
M23 12 Way	10m (30ft)	140144

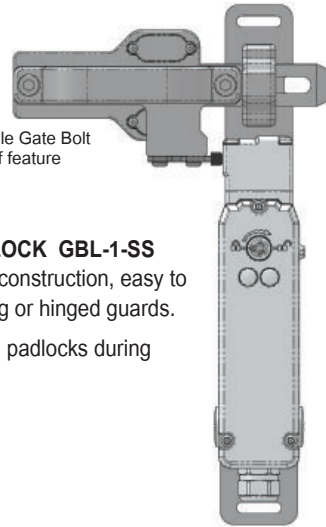

**GATE BOLT LOCK GBL-1-SS**  
Rugged metal construction, easy to install on sliding or hinged guards.  
Holes for fitting padlocks during maintenance.

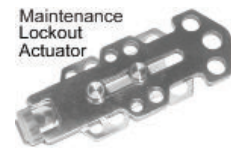

Fits to switch aperture during maintenance and provides multiple padlock holes.



2 colour LED (3 wires) Steady Red and Steady Green. Fits to conduit entry and provides option for LED indication based upon switch contacts.

STAINLESS STEEL 316 GLAND	SALES NUMBER
M20	140120
1/2" NPT	140121



IDEM recommend using our Stainless Steel 316 Gland with this switch.



SALES NUMBER	SOLENOID VOLTAGE	STANDARD MANUAL RELEASE LID AND SIDE			MANUAL RELEASE LID ONLY (Not SIDE)			NO MANUAL RELEASE FITTED (Blanked)		
		M20	1/2" NPT	QC M23	M20	1/2" NPT	QC M23	M20	1/2" NPT	QC M23
Kobra KL4-SS Switch	24V ac/dc	209001	209002	209003	209401	209402	209403	209301	209302	209303
Kobra KL4-SS Switch	110V ac	209004	209005	209006	209404	209405	209406	209304	209305	209306
Kobra KL4-SS Switch	230V ac	209007	209008	209009	209407	209408	209409	209307	209308	209309

Kobra Actuator	Standard	Add A	to Sales Part Number
Kobra Actuator	Flat	Add F	to Sales Part Number
Kobra Actuator	Heavy Duty Flexible	Add HF	to Sales Part Number
Kobra Actuator	S/Steel Heavy Duty Flexible	Add HFH	to Sales Part Number
Momentary Request Push Button (fitted to Lid)		Add PB	to Sales Part Number
1 x Changeover Contact	Common - Closed/Open		
Manual Release Key (order separately - not supplied with switches)			
Sales Number: 140123		<b>Ordering Examples:</b> 24V Solenoid M20 Conduit Standard Manual Release Flat Actuator: Sales Number: 209001-F 110V Solenoid 1/2" NPT Conduit No Manual Release Push Button Standard Actuator: Sales Number: 209305-A-PB 24V Solenoid M20 Conduit Standard Manual Release S/Steel Heavy Flexible Actuator: Sales Number: 209301-HFH	

For all IDEM switches the normally closed (NC) circuits are closed when the guard is closed actuator inserted.