

Guard Locking Switch Metal Type: SAMLOCK KLM

FEATURES:



Spring to lock when actuator is inserted. Energise solenoid to unlock.



STAINLESS STEEL HEAD

Solenoid Locking Interlock Safety Switch featuring Guard Holding up to 3000N (300Kg) (F1Max)

The KLM Series Guard Locking safety switches have rugged Die Cast housings and have been developed with a high holding force of 3000N to keep medium to large guard doors closed until hazards have been removed.

They have a slim profile and are designed to fit on 50mm (2") frame sections or to applications where space is restricted.

The Head will rotate to provide up to 8 actuator entry positions.

They have 2 independent contact blocks to individually monitor the Lock Status and Door Status.

An LED is available to indicate Lock Status.

Versions are available offering a Rear Manual Escape Release.

Accessories include a Sliding Handle Bolt to provide holding of heavy or hinged doors and lock off actuators.

FUNCTIONAL SPECIFICATIONS:

Positive Break Contacts to EN60947-5-1 
 High Functional Safety to ISO13849-1
 Stainless Steel 316 Head version available
 Connects to most Safety Relays to give up to PLe Cat.4
 Quick Connector version available for ease of installation

4NC Safety Circuits:
 2 Solenoid/Lock 2 Actuator/Guard
 1NO Auxiliary Circuit:
 For indication of Actuator Status (guard open)
 1NO Auxiliary Circuit:
 For Lock Status (selectable with LED2)

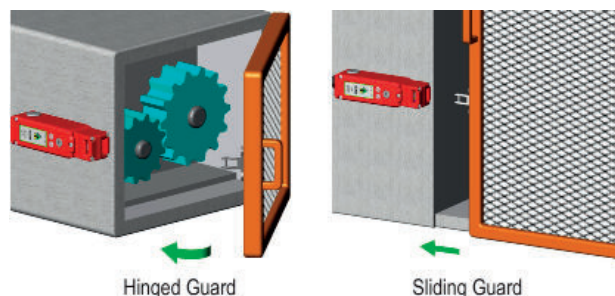

Hinged Guard

Sliding Guard

ACTUATOR OPTIONS (see p100)



Top or Side Manual Release points

8 actuator entry positions rotatable head

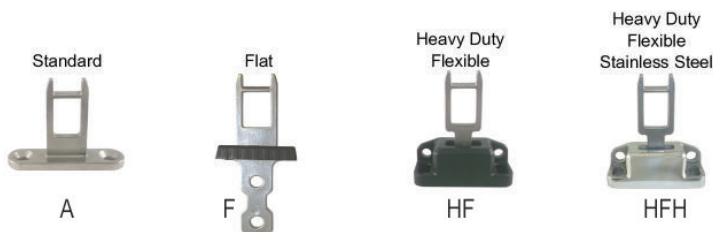

Standards: ISO14119 EN60947-5-1 EN6204-1
 ISO13849-1 EN62061 UL508

Safety Classification and Reliability Data:

Mechanical Reliability B10d	2.5 x 10 ⁶ operations at 100mA load
ISO13849-1	Up to PLe depending upon system architecture
EN62061	Up to SIL3 depending upon system architecture
Safety Data – Annual Usage	8 cycles per hour/24 hours per day/365 days
	MTTFd 356 years
Solenoid Voltage (by Sales Number)	24V ac/dc or 110Vac or 230Vac
Solenoid Wattage	12W
LED 2 Supply Voltage	24Vdc
Utilization Category	AC15 A300 3A
Thermal Current (Ith)	5A
Rated Insulation/Withstand Voltages	600Vac/2500Vac
Travel for Positive Opening	10mm
Actuator Entry Minimum Radius	175mm Standard 100mm Heavy Duty
Maximum Approach/Withdrawal Speed	600mm/s
Holding Force	F1Max 3000N Fzh 2307N
Body Material	Die Cast (painted red)
Head Material	Die Cast (painted red) or Stainless Steel 316
Enclosure Protection	IP67
Operating Temperature	-25C +50C
Vibration	IEC 68-2-6 10-55Hz + 1Hz
	Excursion 0.35mm 1 octave/min
Conduit Entry	Various (See Sales Number)
Fixing	4 x M5

INSERTION OF ACTUATOR

	6.0	5.0	0mm
11/12	Open		
21/22	Open		
33/34			Open
43/44			Open

For all IDEM switches the normally closed (NC) circuits are closed when the guard is closed actuator inserted.

Guard Locking Switch Metal Type: SAMLOCK KLM



SCHEMATIC CIRCUIT:

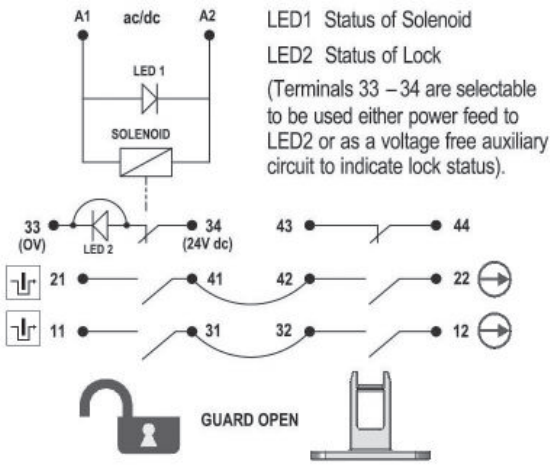

DIMENSIONS:

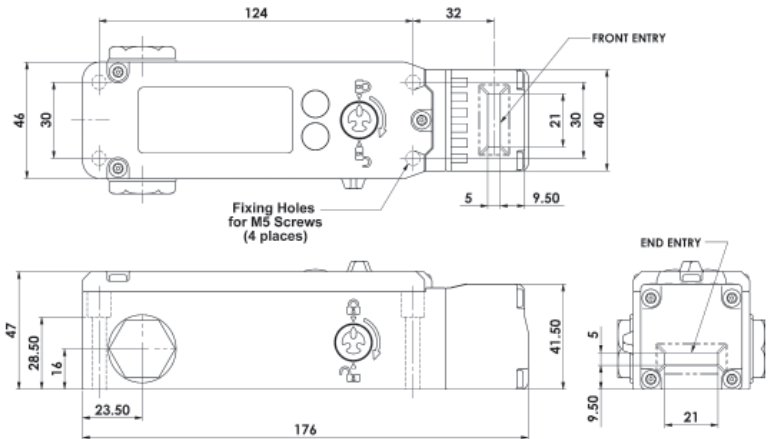

RELATED PRODUCTS & ACCESSORIES (see p100-101 and Gate Bolts Section 6)



Sliding Handle Gate Bolt with Lock Off Feature

GATE BOLT LOCK

Rugged metal construction, easy to install on sliding or hinged guards.

Holes for fitting padlocks during maintenance.

Painted yellow and comes with plastic handle and flat actuator.



2 Colour LED Conduit Beacon

2 colour LED (3 wires) Steady Red and Steady Green. Fits to conduit entry and provides option for LED indication based upon switch contacts.

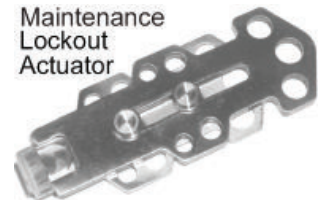

Maintenance Lockout Actuator

Fits to switch aperture during maintenance and provides multiple padlock holes.

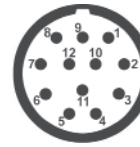

Quick Connect (QC) M23 12 Way Male Plug Connector Length 24mm Pin View from Switch	Switch Circuit	
1 3	A1	A2
4 6	11/12	
7 8	21/22	
2 5	43/44	
9	33	
10	34	
12	Earth	

FEMALE QC LEADS	LENGTH	SALES NUMBER
M23 12 Way	5m (15ft)	140143
M23 12 Way	10m (30ft)	140144

REAR MANUAL RELEASE VERSION

Rear push button manual release version provides a means of escape from inside the guarded area.



SALES NUMBER	SOLENOID VOLTAGE	STANDARD MANUAL RELEASE LID AND SIDE			MANUAL RELEASE LID ONLY (Not SIDE)			NO MANUAL RELEASE FITTED (Blanked)		
		M20	1/2" NPT	QC M23	M20	1/2" NPT	QC M23	M20	1/2" NPT	QC M23
Kobra KLM Switch	24V ac/dc	202001	202002	202003	202401	202402	202403	202301	202302	202303
Kobra KLM Switch	110V ac	202004	202005	202006	202404	202405	202406	202304	202305	202306
Kobra KLM Switch	230V ac	202007	202008	202009	202407	202408	202409	202307	202308	202309

Kobra Actuator	Standard		Add A	to Sales Part Number
Kobra Actuator	Flat		Add F	to Sales Part Number
Kobra Actuator	Heavy Duty Flexible		Add HF	to Sales Part Number
Kobra Actuator	S/Steel Heavy Duty Flexible		Add HFH	to Sales Part Number
	Stainless Steel Head Versions		Add SS	to Sales Part Number

Ordering Examples:

Kobra KLM 24V Solenoid M20 Conduit Standard Manual Release Stainless Steel Head Flat Actuator: Sales Number: 202001-SS-F
 Kobra KLM 110V Solenoid 1/2" NPT Conduit No Manual Release Standard Actuator: Sales Number: 202305-A