

RFID Guard Locking Switch Plastic Type: ARTALOCK KLP-Z

FEATURES:

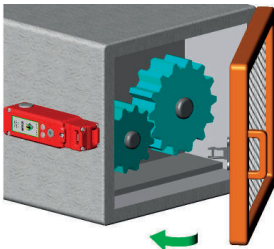

Hinged Guard

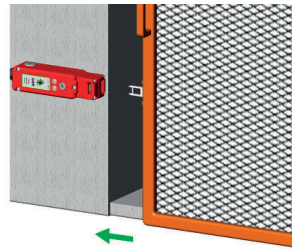

Sliding Guard

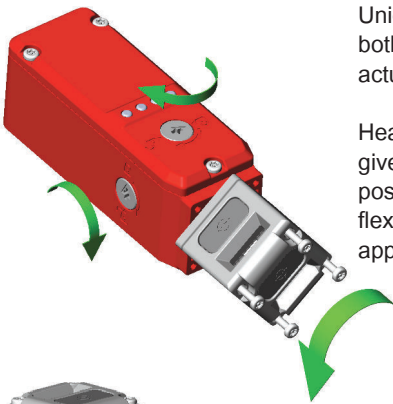

Unique design offering both Front or End entry actuation.

Head will rotate to give 8 actuator entry positions for full flexibility depending on application.



Front entry actuation direction.

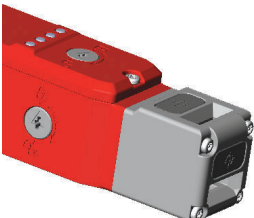

End entry actuation direction.

Solenoid Locking Interlock Safety Switch featuring RFID Interlocking

The KLP-Z Series Guard Locking switches have been designed to incorporate high anti-tamper RFID coding and provide PLe safety levels to ISO13849-1.

The RFID sensing is complemented by a traditional cam locking system which has been developed with a holding Force of 2000N to keep guard doors closed until hazards have been removed.

Unique rotating head to offer both Front and End actuation.

32 million RFID codes – each switch unique – high coding to ISO14119.

Rugged IP67 enclosure protection is maintained by a double seal lid gasket design and metal fixings.

They have a slim profile and are designed to fit on 50mm (2in) frame sections or to applications where space is restricted and the head will rotate to provide up to 8 actuator entry positions and includes front and end entry sensing.

High specification plastic housing with robust Stainless Steel 316 head.

Choice of standard or flexible actuators.

M12 Quick connect version available.

FUNCTIONAL SPECIFICATIONS:

Solid State OSSD Safety Outputs short circuit protected.

High Functional Safety to ISO13849-1, maintains PLe Interlocking via self-test technique when switches are connected in series to a safety controller or relay.

2 Safety Circuits - closed when switch is locked and machine able to run.

1 Auxiliary circuit for indication of Guard status (Guard open).

1 Auxiliary circuit for indication of Lock Status (Guard locked).

4 diagnostic LED's to display guard position, lock, input/output signals and fault status.

ACTUATOR OPTIONS:

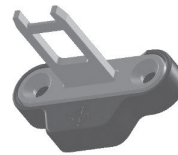

AZ Standard Actuator



HFZ Flexible Actuator

Standards: IEC60947-5-3 ISO14119 ISO13849-1 IEC62061 UL508

Safety Classification and Reliability Data:

Supply Voltage	24Vdc (+/- 10%)
Power Consumption	R+ (50mA Max.) S+ (500mA Max) (Solenoid)
Safety Circuits (11-12, 21-22)	24V 0.2A
Auxiliary Circuits (34 and 44)	24Vdc 0.2A Max. output current
Rated Insulation Voltage	500VAC
Holding Force (ISO14119)	F1 Max 2000N Fzh 1538N
Actuator insertion distance for assured locking	5mm
Sao Sar (RFID sensing)	Sao 10mm Sar 20mm
Operating Frequency	1Hz
Actuator entry minimum radius	175mm Standard 100mm Flexible
Body Material	Polyester
Head Material	Stainless Steel 316
Actuator Material	Stainless Steel 316
Enclosure Protection	IP67
Operating Temperature	-25C to +40C
Mechanical Life Expectancy	2.5 x 10 ⁶ cycles
Vibration	IEC88-2-6, 10-55Hz + 1Hz Excursion 0.35mm 1 octave/min

Characteristic data according to IEC62061 (used as a subsystem)

Safety Integrity Level	SIL 3
PFH (1/h)	4.80 E-10 Corresponds to 4.8% of SIL3
Proof Test Interval T ₁	20a

Characteristic data according to EN ISO13849-1

Performance Level	e	If both channels are used in conjunction with a SIL 3/PLe control device.
Category	Cat 4	
MTTF _d	1100a	
Diagnostic Coverage DC	99% (high)	

RFID Guard Locking Switch Plastic Type: ARTALOCK KLP-Z

SCHEMATIC & CONNECTION EXAMPLE:

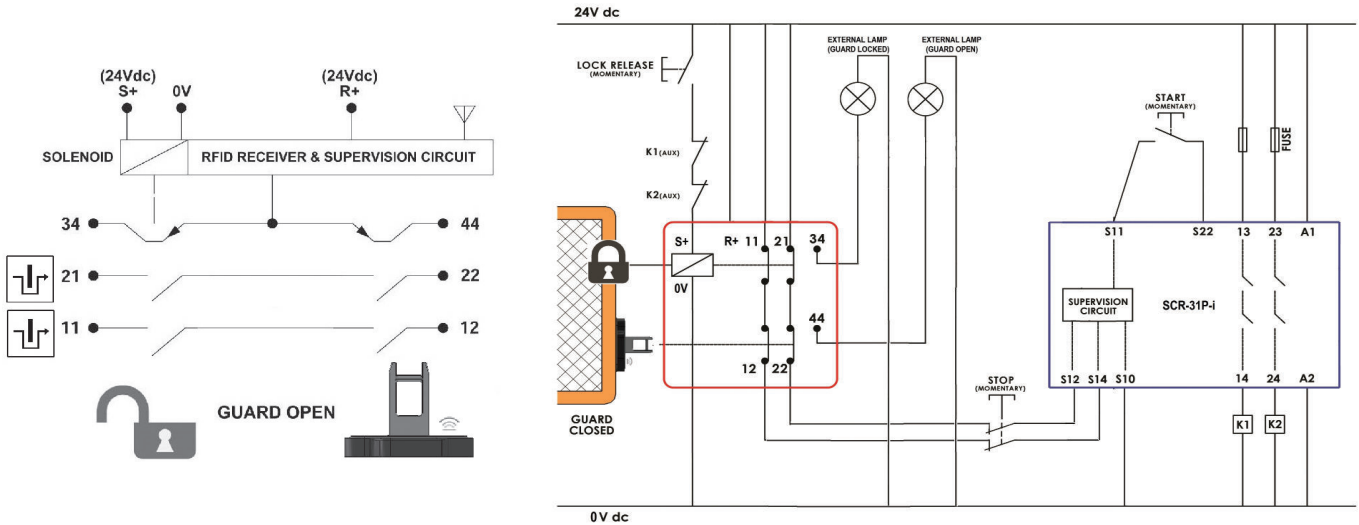

DIMENSIONS:

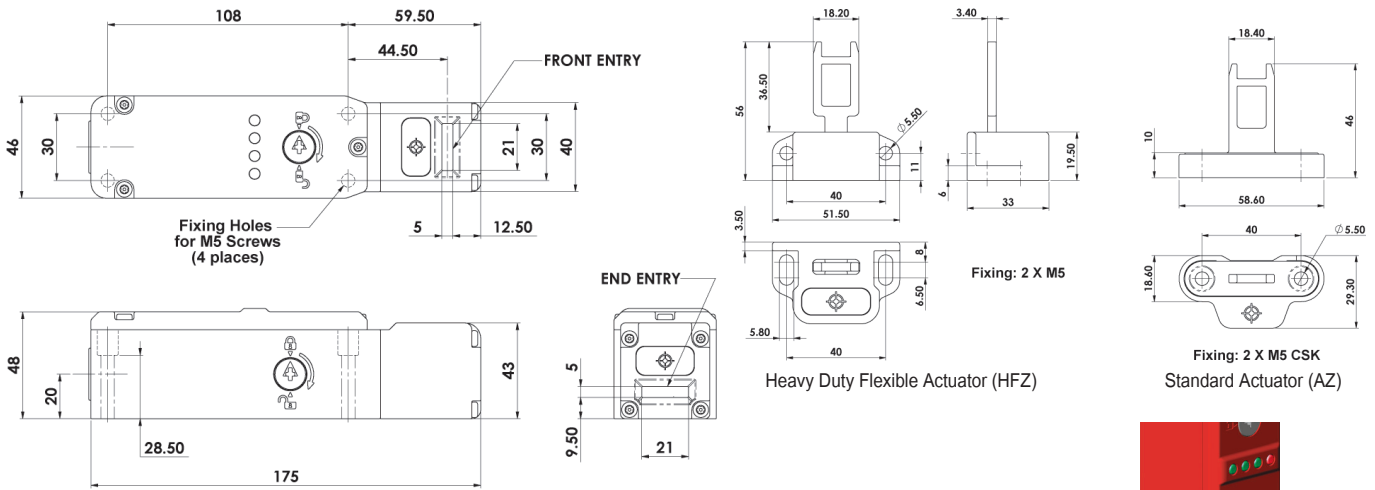

FEMALE QC LEADS	LENGTH	SALES NUMBER
M12 8 Way	5m (15ft)	140101
M12 8 Way	10m (30ft)	140102

LED 1 Guard State	
Guard Locked	Green
Guard Unlocked	Green (Flashing)
Incorrect Code	Red (Flashing)
Guard Open	Red

Quick Connect (QC) M12 8 Way Male Plug Pin View from Switch	Terminal	Function	Switch Circuit	Rating
2	R+	24V dc	Supply 24V dc	50mA max.
3	0V	0V dc	Supply 24V dc (Ground)	
7	11	Safety Input 1	Safety Circuit 1	200mA max.
1	12	Safety Output 1		
4	21	Safety Input 2	Safety Circuit 2	200mA max.
6	22	Safety Output 2		
8	44	Auxiliary (Guard Open)	Guard open signal +24V dc out	200mA max.
N/A	34	Auxiliary (Guard Locked)	Guard locked signal +24V dc out	200mA max.
5	S+	Unlocked	Unlock signal apply +24V dc	500mA max.

LED 2 Input	
Safety Inputs On	Green
Safety Inputs Off	Off

LED 3 Output	
Safety Outputs On	Green
Safety Outputs Off	Off

LED 4 Solenoid	
Solenoid Energised	Red
Solenoid De-energised	Off



DESCRIPTION	M20	1/2" NPT	QC M12	M20	1/2" NPT	QC M12	M20	1/2" NPT	QC M12
KLP-Z Switch with STANDARD Actuator	455001AZ	455002AZ	455003AZ	455401AZ	455402AZ	455403AZ	455301AZ	455302AZ	455303AZ
KLP-Z Switch with HEAVY DUTY FLEXIBLE Actuator	455001HFZ	455002HFZ	455003HFZ	455401HFZ	455402HFZ	455403HFZ	455301HFZ	455302HFZ	455303HFZ

For all IDEM switches the normally closed (NC) circuits are closed when the guard is closed actuator inserted.