

IDECODE - Coded Non Contact Type: MPC

FEATURES:

- Compact and robust fitting suitable for all small guard applications.
- LED indication
- Hygienic screw covers ensure suitability for Food Processing washdown
- Cost-effective interlock solution
- Wide sensing at 10mm
- High specification polyester housing with integral back plate
- Can be mounted unobtrusively in channels or behind doors
- Left or right cable exit options available
- Up to: PLe ISO13849-1
- 2NC 1NO circuits - high switching life - no moving parts

DIMENSIONS:

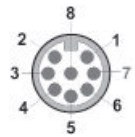
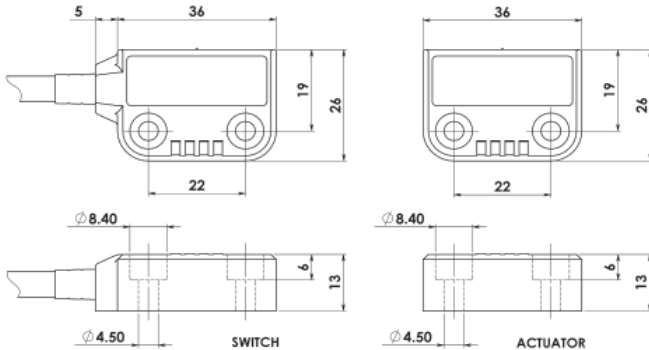

Quick Connect M12 versions fitted with 250mm (10") cable

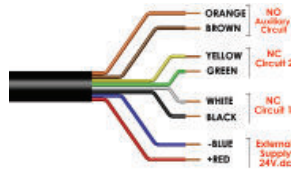

Quick Connect QC M12 8 Way Male Plug Pin view from Switch	Flying Lead Colour	Circuit (Actuator Present)	Output Types Solid State
8	Orange	Auxiliary NO or NC	200mA Max. 24Vdc
5	Brown	Auxiliary NO or NC	
4	Yellow	Safety NC2	200mA Max. 24Vdc
6	Green	Safety NC2	
7	Black	Safety NC1	200mA Max. 24Vdc
1	White	Safety NC1	
2	Red	Supply +24Vdc	Supply 24Vdc +/- 10%
3	Blue	Supply 0Vdc	

	140101	Female QC Lead	M12 Female 5m. 8 way
	140102	Female QC Lead	M12 Female 10m. 8 way

Standards: ISO14119 EN60947-5-1
EN60204-1 ISO13849-1 EN62061 UL508

Safety Classification and Reliability Data:

ISO13849-1	Up to PLe Category 4
PFHd	2.6×10^{-10}
Proof Test Interval (Life)	20 years
MTTFd	866 years
Safety Channel 1 NC	24Vdc 0.2A Max. Rating
Safety Channel 2 NC	24Vdc 0.2A Max. Rating
Safety Channel 3 NO	24Vdc 0.2A Max. Rating
Minimum Switched Current	10Vdc 1mA
Dielectric Withstand	250Vac
Insulation Resistance	100 Mohms
Recommended Setting Gap	5mm
Switching Distance (Target to Target)	Sao 8mm Close Sar 12mm Open
Tolerance to Misalignment	5mm in any direction from 5mm setting gap
Switching Frequency	1.0Hz maximum
Approach Speed	200mm/min to 1000mm/sec
Body Material	UL approved polyester
Operating Temperature	-25C +80C
Enclosure Protection	IP69K IP67
Shock Resistance	IEC68-2-27 11ms 30g
Vibration Resistance	IEC68-2-6 10-55Hz 1mm
Cable Type	PVC 6 or 8 core 6mm OD Conductors 0.25mm ²
Mounting Bolts	2xM4 Tightening torque 1.0Nm
Mounting Position	Any

For all IDEM switches the normally closed (NC) circuits are closed when the guard is closed and the actuator is present.



Coded Magnetic Actuation Switching Tolerance up to 10mm Will operate with most Safety Relays

Supplied with Screw Cap covers to prevent contamination from food deposits



Quick Connect M12 versions fitted with 250mm (10") cable



Left or Right Cable Exit Options available

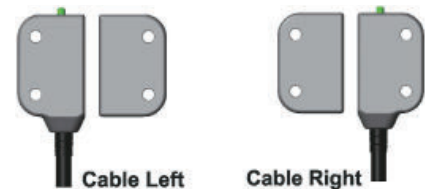

CONNECTION EXAMPLE: CODED SWITCH

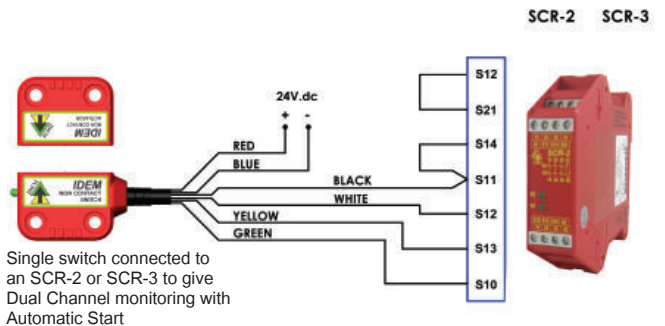

Single switch connected to an SCR-2 or SCR-3 to give Dual Channel monitoring with Automatic Start

SALES NUMBER	TYPE	CABLE LENGTH	CIRCUITS
114101	MPC Cable Right	2M	2NC
114102	MPC Cable Right	5M	2NC
114103	MPC Cable Right	10M	2NC
114104	MPC Cable Right	QC-M12*	2NC
114105	MPC Cable Right	2M	2NC 1NO
114106	MPC Cable Right	5M	2NC 1NO
114107	MPC Cable Right	10M	2NC 1NO
114108	MPC Cable Right	QC-M12*	2NC 1NO
114117	MPC Cable Right	2M	3NC
114118	MPC Cable Right	5M	3NC
114119	MPC Cable Right	10M	3NC
114120	MPC Cable Right	QC-M12*	3NC
114109	MPC Cable Left	2M	2NC
114110	MPC Cable Left	5M	2NC
114111	MPC Cable Left	10M	2NC
114112	MPC Cable Left	QC-M12*	2NC
114113	MPC Cable Left	2M	2NC 1NO
114114	MPC Cable Left	5M	2NC 1NO
114115	MPC Cable Left	10M	2NC 1NO
114116	MPC Cable Left	QC-M12*	2NC 1NO
114121	MPC Cable Left	2M	3NC
114122	MPC Cable Left	5M	3NC
114123	MPC Cable Left	10M	3NC
114124	MPC Cable Left	QC-M12*	3NC

*Other QC (Quick Connect) sizes available upon request.

Note: 2NC 1NO versions have 2NC Safety and 1NO Auxiliary Circuits
3NC versions have 2NC Safety and 1NC Auxiliary Circuits
AVAILABLE WITHOUT LED IF REQUIRED.