

# IDECODE - Coded Non Contact Type: SPC

## FEATURES:

Universal fitting - established 22mm footprint suitable for most applications  
 Withstands environments where high humidity or hose down is required  
 High specification and durable polyester housing  
 Wide 14mm sensing with high tolerance to misalignment  
 Up to: PLe ISO13849-1  
 2NC 1NO circuits - high switching life - no moving parts  
 Quick Connect versions available

## DIMENSIONS:

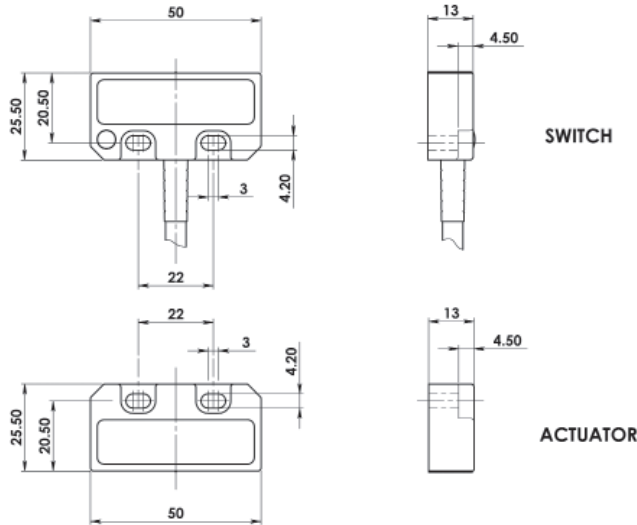

**Coded Magnetic Actuation**  
**Switching Tolerance up to 14mm**  
**Will operate with most Safety Relays**



Quick Connect M12 versions fitted with 250mm (10") cable



## CONNECTION EXAMPLE: CODED SWITCH

Single switch connected to an SCR-21-i or SCR-31-i to give Dual Channel monitoring with monitored Manual Start

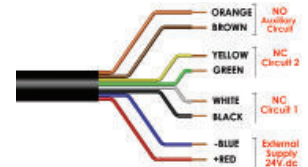
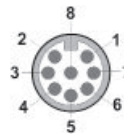
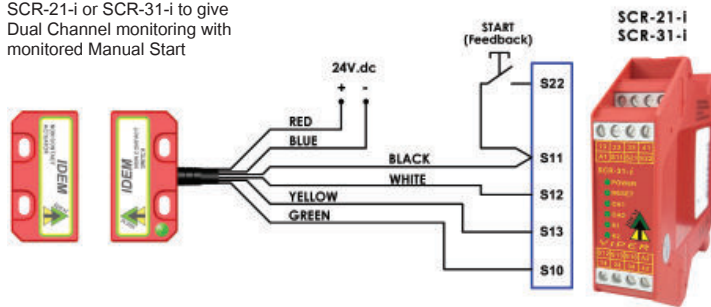

140101	Female QC Lead	M12 Female 5m. 8 way
140102	Female QC Lead	M12 Female 10m. 8 way

**Standards:** ISO14119 EN60947-5-1  
 EN60204-1 ISO13849-1 EN62061 UL508

### Safety Classification and Reliability Data:

ISO13849-1	Up to PLe Category 4
PFHd	$2.6 \times 10^{-10}$
Proof Test Interval (Life)	20 years
MTTFd	866 years
Safety Channel 1 NC	24Vdc 0.2A Max. Rating
Safety Channel 2 NC	24Vdc 0.2A Max. Rating
Safety Channel 3 NO	24Vdc 0.2A Max. Rating
Minimum Switched Current	10Vdc 1mA
Dielectric Withstand	250Vac
Insulation Resistance	100 Mohms
Recommended Setting Gap	5mm
Switching Distance (Target to Target)	Sao 10mm Close Sar 20mm Open
Tolerance to Misalignment	5mm in any direction from 5mm setting gap
Switching Frequency	1.0Hz maximum
Approach Speed	200mm/min to 1000mm/sec
Body Material	UL approved polyester
Operating Temperature	-25C +80C
Enclosure Protection	IP69K IP67
Shock Resistance	IEC68-2-27 11ms 30g
Vibration Resistance	IEC68-2-6 10-55Hz 1mm
Cable Type	PVC 6 or 8 core 6mm OD Conductors 0.25mm <sup>2</sup>
Mounting Bolts	2xM4 Tightening torque 1.0Nm
Mounting Position	Any

For all IDEM switches the normally closed (NC) circuits are closed when the guard is closed and the actuator is present.

Quick Connect QC M12 8 Way Male Plug Pin view from Switch	Flying Lead Colour	Circuit (Actuator Present)	Output Types Solid State
8	Orange	Auxiliary NO or NC	200mA Max. 24Vdc
5	Brown	Auxiliary NO or NC	200mA Max. 24Vdc
4	Yellow	Safety NC2	200mA Max. 24Vdc
6	Green	Safety NC2	200mA Max. 24Vdc
7	Black	Safety NC1	200mA Max. 24Vdc
1	White	Safety NC1	200mA Max. 24Vdc
2	Red	Supply +24Vdc	Supply 24Vdc
3	Blue	Supply 0Vdc	+/- 10%

SALES NUMBER	TYPE	CABLE LENGTH	CIRCUITS
111001	Idecode SPC	2M	2NC
111002	Idecode SPC	5M	2NC
111003	Idecode SPC	10M	2NC
111004	Idecode SPC	QC-M12	2NC
111005	Idecode SPC	2M	2NC 1NO
111006	Idecode SPC	5M	2NC 1NO
111007	Idecode SPC	10M	2NC 1NO
111008	Idecode SPC	QC-M12	2NC 1NO
111105	Idecode SPC	2M	3NC
111106	Idecode SPC	5M	3NC
111107	Idecode SPC	10M	3NC
111108	Idecode SPC	QC-M12	3NC

Note: 2NC 1NO versions have 2NC Safety and 1NO Auxiliary Circuits  
 3NC versions have 2NC Safety and 1NC Auxiliary Circuits

**AVAILABLE WITHOUT LED IF REQUIRED.**